

PRO

BACKLIGHT



PRO

Modern and rational,
Flush has a minimal and clean body.
The perfect ally where a recessed light
is required. It is the product which best
characterises the leitmotiv and has always
guided us: the obsession for form.

projecting edge - made to measure

- 36 SECTION
- 37 STANDARD
- 38 TECHNICAL SPECS
- 39 CABLE OPTIONS
- 40 TERMINALS
- 41 FINISH OPTIONS
- 43 FIXING SYSTEM

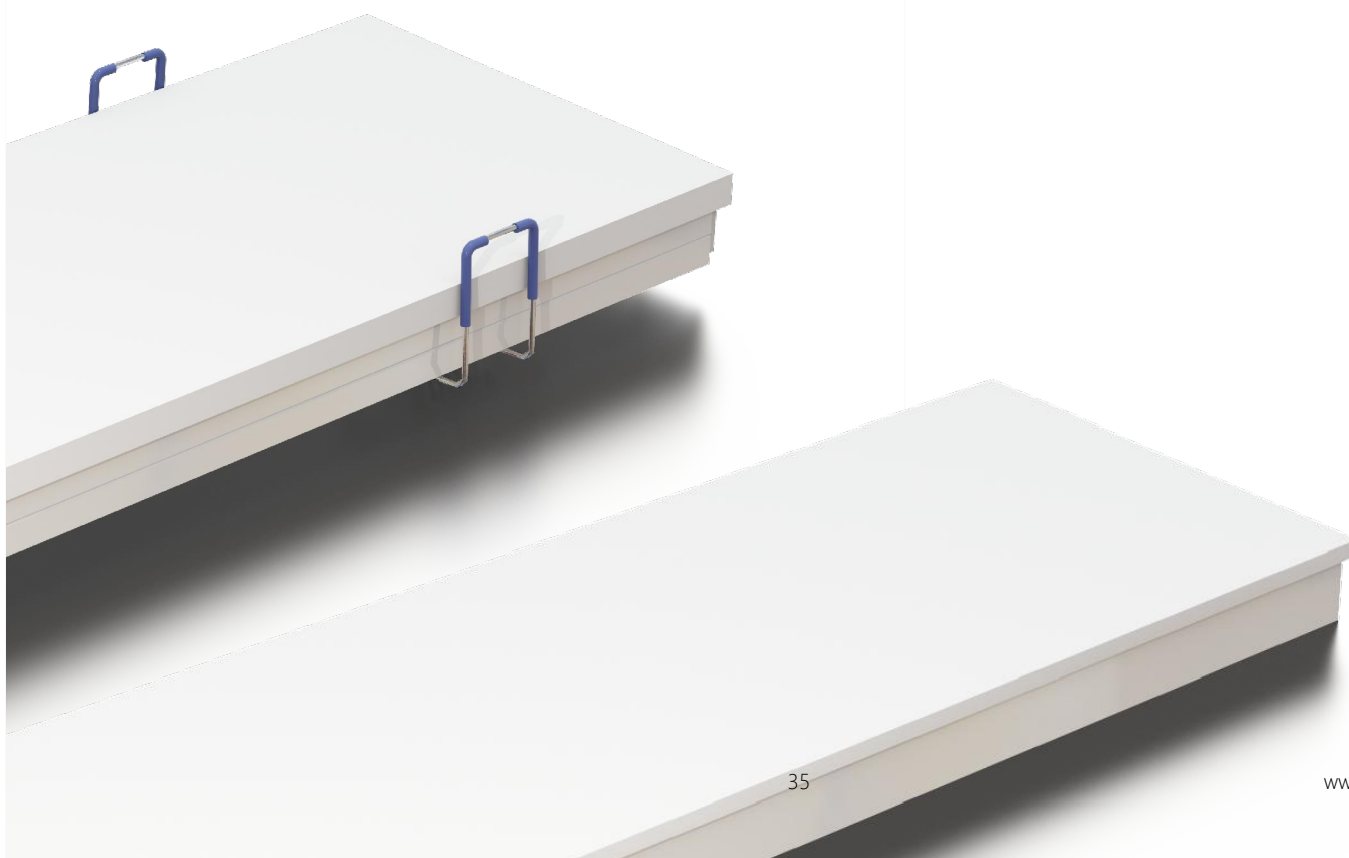

SECTION

PRO

STANDARD MODELS

Section with magnets

ALL SCREWS
by others

IRON PLATE
to screw on surface or recess

MAGNETS
part of Backlight PRO

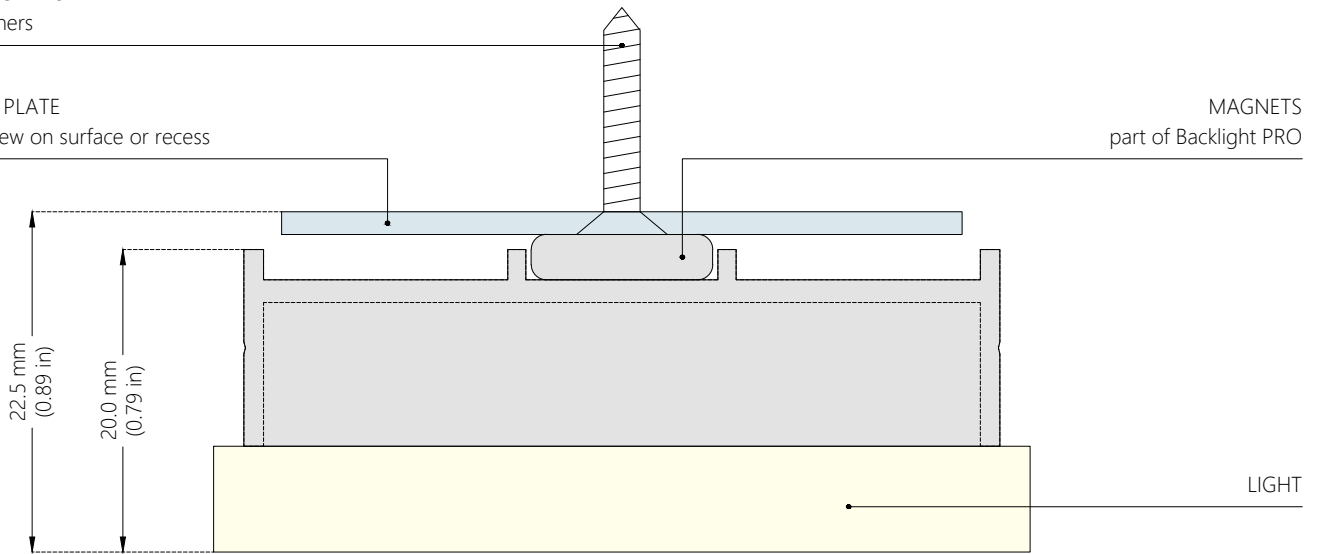

Section with springs

SPRINGS
part of Backlight PRO

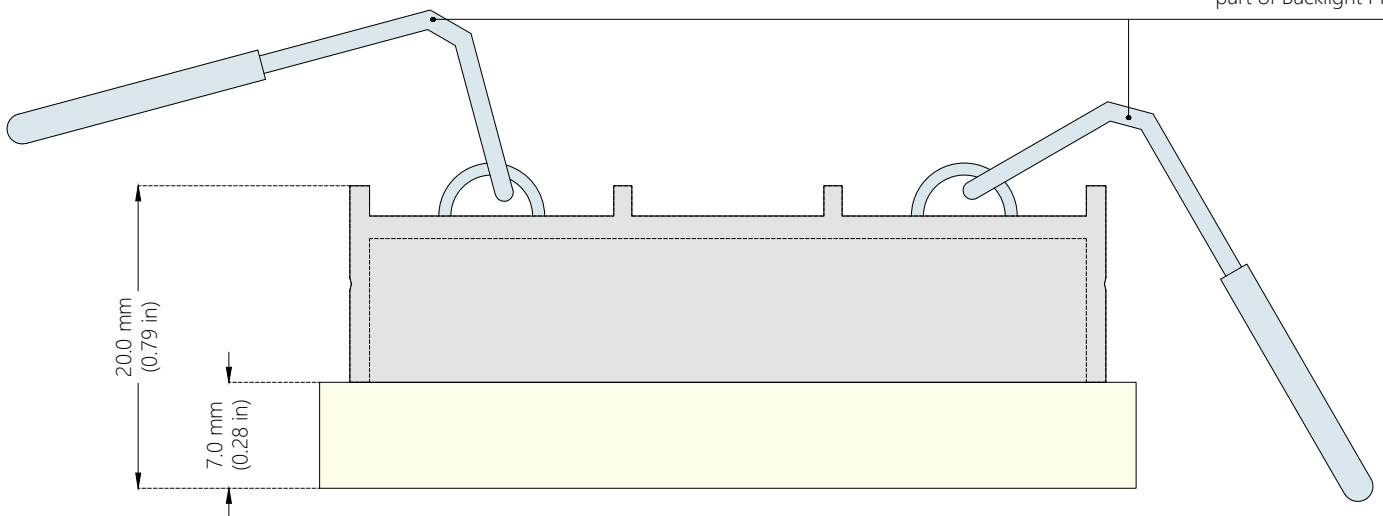

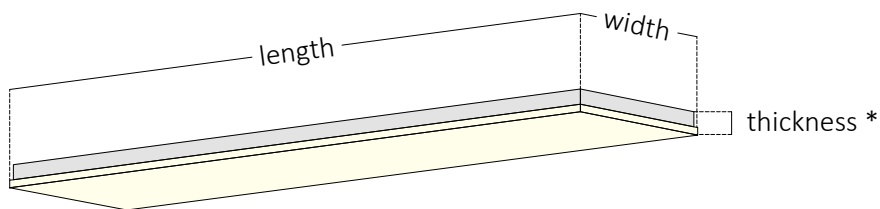

* excluding iron plate and magnets

STANDARD

PRO

14 W per line meter (4.5 W per line ft)

| name | width | length | thickness | light temps. available | cable options | lumen delivered | use | mounting system |
|-------|--------|--------|---|-----------------------------------|---|--------------------------|-----------------|--------------------|
| FLUSH | 19 mm | 0.8 in | min 101.6 mm max 3048 mm (min 4.0 in) (max 120.0 in) | 20 mm (0.79 in) (see p. 36) | 2700 K 3200 K 3500 K 4100 K 5000 K Tunable W RGB RGB + W | 890 lm/mt (280 lm/ft) | CEILING WALL | MAGNETS SPRINGS |
| | 29 mm | 1.2 in | | | | | | |
| | 34 mm | 1.4 in | | | | | | |
| | 39 mm | 1.6 in | | | | | | |
| | 44 mm | 1.8 in | | | | | | |
| | 54 mm | 2.2 in | | | | | | |
| | 59 mm | 2.4 in | | | | | | |
| | 80 mm | 3.2 in | | | | | | |
| | 104 mm | 4.2 in | | | | | | |
| | 204 mm | 8.2 in | | | | | | |











28 W per line meter (9 W per line ft)

| name | width | length | thickness | light temps. available | cable options | lumen delivered | use | mounting system |
|-------|--------|--------|---|-----------------------------------|---|---------------------------|-----------------|--------------------|
| FLUSH | 44 mm | 1.8 in | min 101.6 mm max 3048 mm (min 4.0 in) (max 120.0 in) | 20 mm (0.79 in) (see p. 36) | 2700 K 3200 K 3500 K 4100 K 5000 K Tunable W RGB RGB + W | 1632 lm/mt (570 lm/ft) | CEILING WALL | MAGNETS SPRINGS |
| | 54 mm | 2.2 in | | | | | | |
| | 59 mm | 2.4 in | | | | | | |
| | 80 mm | 3.2 in | | | | | | |
| | 104 mm | 4.2 in | | | | | | |
| | 204 mm | 8.2 in | | | | | | |

TECHNICAL SPECS

PRO

GENERAL SPECIFICATION

| | | |
|---------------------|---|--|
| DIMENSION | MM width 19 - 29 - 34 - 39 - 44 - 54 - 59 - 80 - 104 - 204 mm INCHES width 0.8 - 1.2 - 1.4 - 1.6 - 1.8 - 2.2 - 2.4 - 3.2 - 4.2 - 8.2 in MM / INCHES thickness (see p. 36) | MM length 101.6 to 3048.0 mm INCHES length 4.0 to 120.0 in |
| COLOUR TEMPERATURES |  2700 K  3200 K  3500 K  4100 K  5000 K  Tunable white  RGB  RGB +W and other K under request | |
| INPUT VOLTAGE | 24V DC | |
| DRIVER | AC DC 24V DC OUTPUT (class 2 Power Unit) | |
| DIMMABILITY | by all existing systems | |
| POWER CONSUMPTION | Standard bright 14 W per linear mt (4.5 W per linear ft) High bright 28 W per linear mt (9.0 W per linear ft) | |
| WEIGHT | 5.7 lbs/sq. ft (25 Kg/sq. mt) | |
| IP GRADE | IP40 | IP54 (under request) |
| CRI | RA 85 | RA min. 90 R9 min. 50 |
| LUMEN DELIVERED | Standard bright 280 lm per linear ft (890 lm per linear mt) High bright 570 lm per linear ft (1632 lm per linear mt) | |
| LIFE TIME | 70.000 hrs | |
| WARRANTY | 3 Years (36 month) | |
| CERTIFICATIONS |   | <ul style="list-style-type: none"> • Ceiling surface Mounted • Ceiling recessed Type IC Inherently protected • Wall surface Mounted • NEW Storage Area of a Clothes Closet • UL94 (in accordance with the requirements of ASTM E 84, ANSI / UL 723, or CAN / ULC-S102)* |

* to be asked at the order time if needed.

CABLE OPTIONS

PRO

Options for max 42 W panels

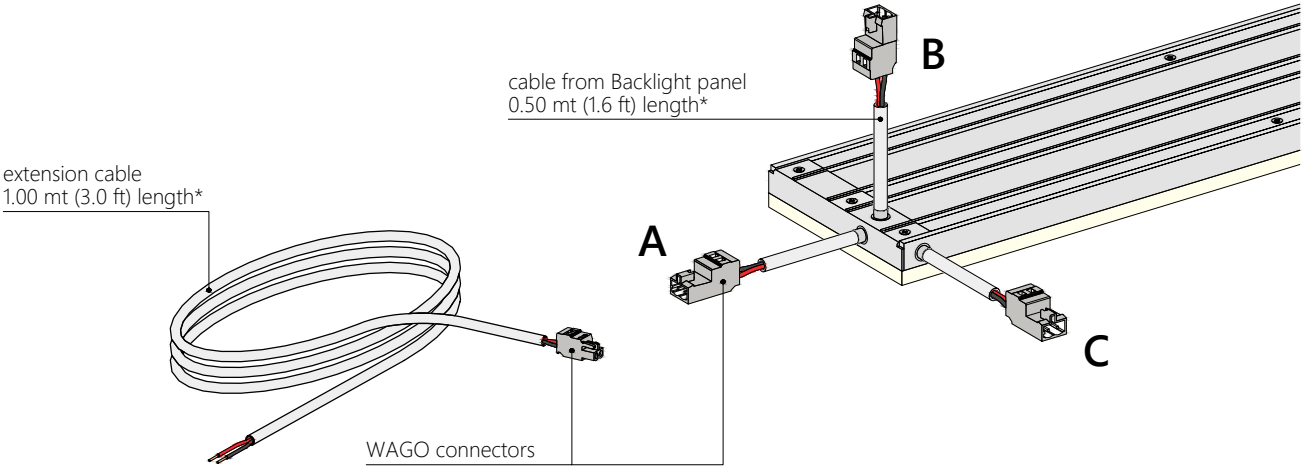

Options for panels with power higher then 42 W (2 cables needed)

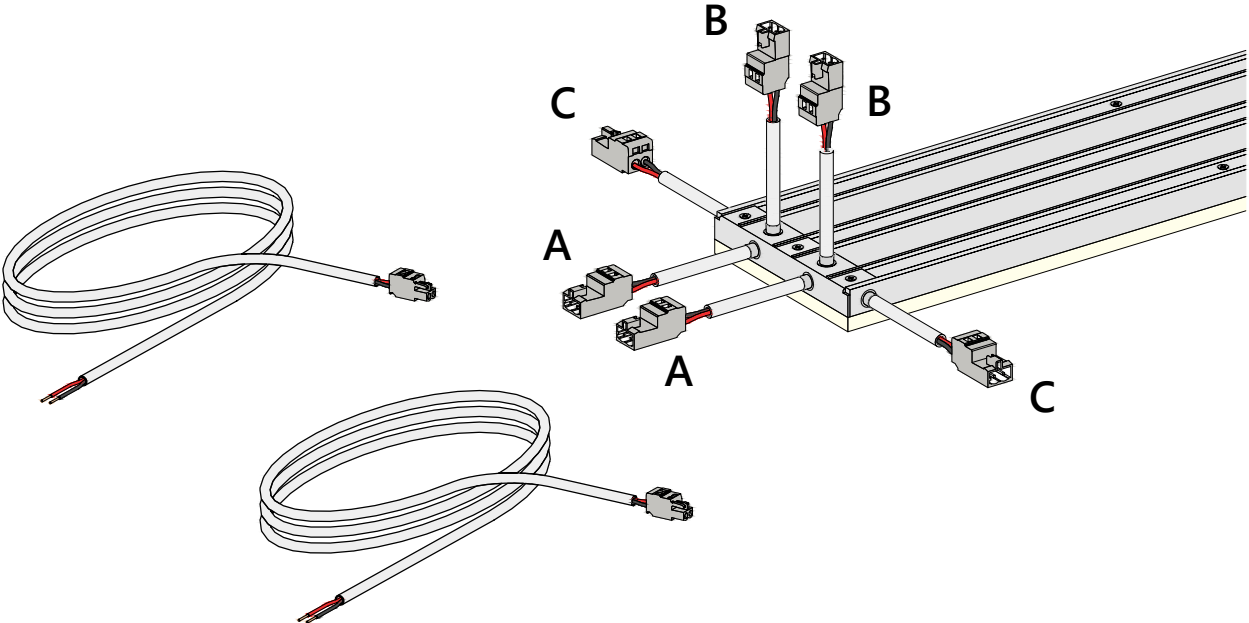

* custom length under request MAX 20 mt (65.0 ft)

TERMINALS

PRO

Backlight products can be ordered with 2D or 3D custom terminal cut*

2D terminal cut



3D terminal cut

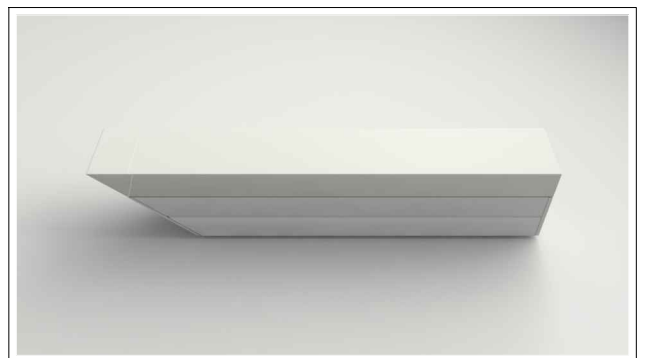
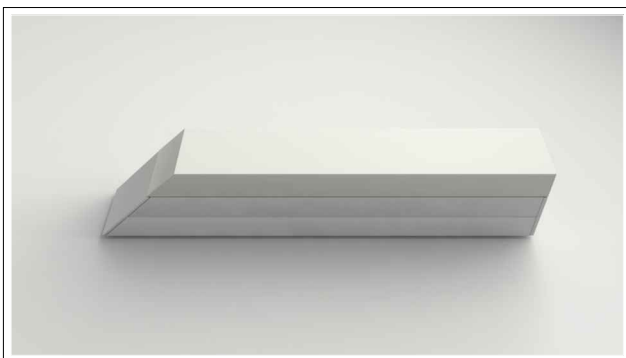

FINISH OPTIONS

PMMA FACE WORKING

PRO

Lowering of the surface for your framing accomodation

On lighting surface

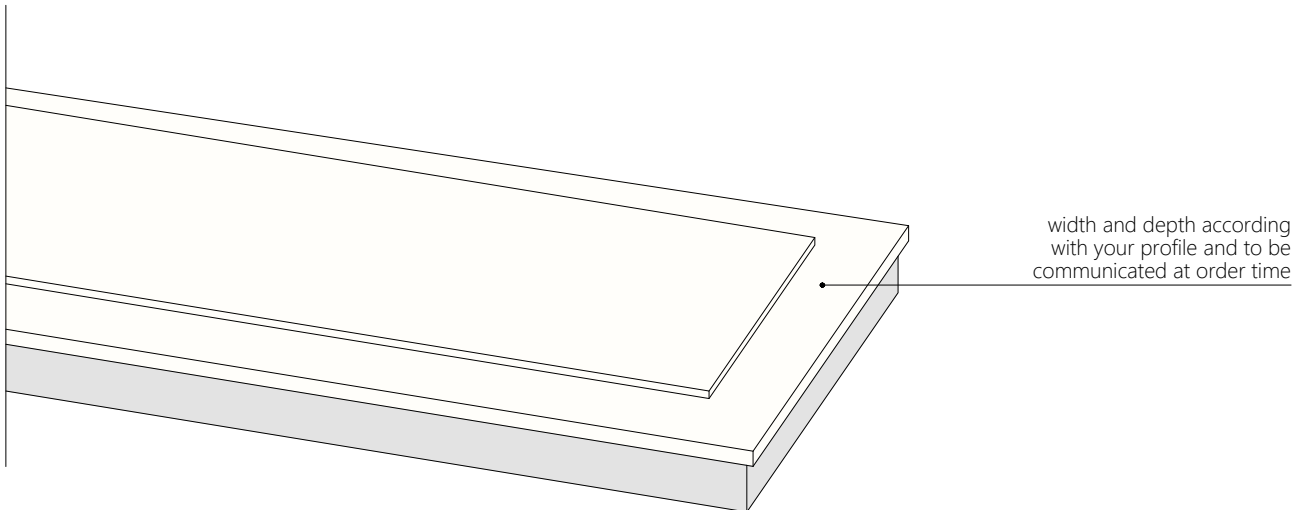

width and depth according
with your profile and to be
communicated at order time

FINISH OPTIONS

PRINTING TEXTURES

PRO

Standard marble collection

Printing on Backlight surface using a new UV technology

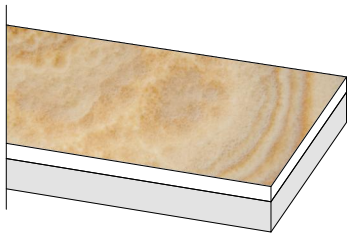

HONEY

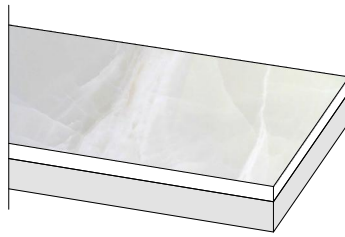

WHITE ONYX



WHITE ONYX 2

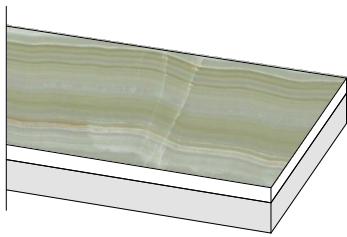

JADE GREEN



BKL MARBLE

Custom file

Printing on Backlight surface using a new UV technology



1) DESIGNER
to choice/create an High Resolution
image and e-mail the HR JPEG file to
Backlight srl

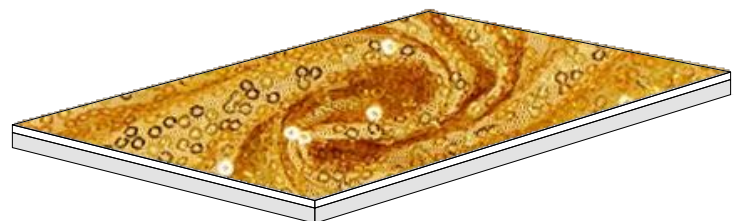

2) BACKLIGHT srl
will produce the lighting
custom texture panel
100% under request by: size, K, cable option, fixing

FIXING SYSTEM

PRO

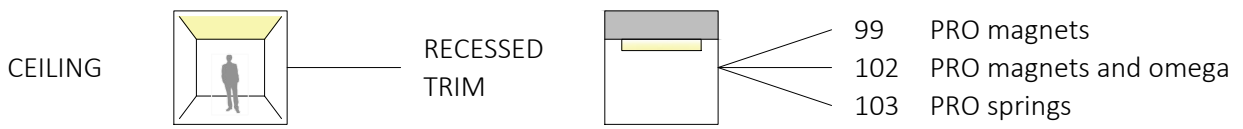

CEILING

RECESSED TRIM



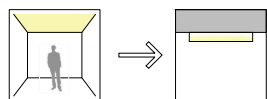

POSSIBLE CUSTOM SHAPES :

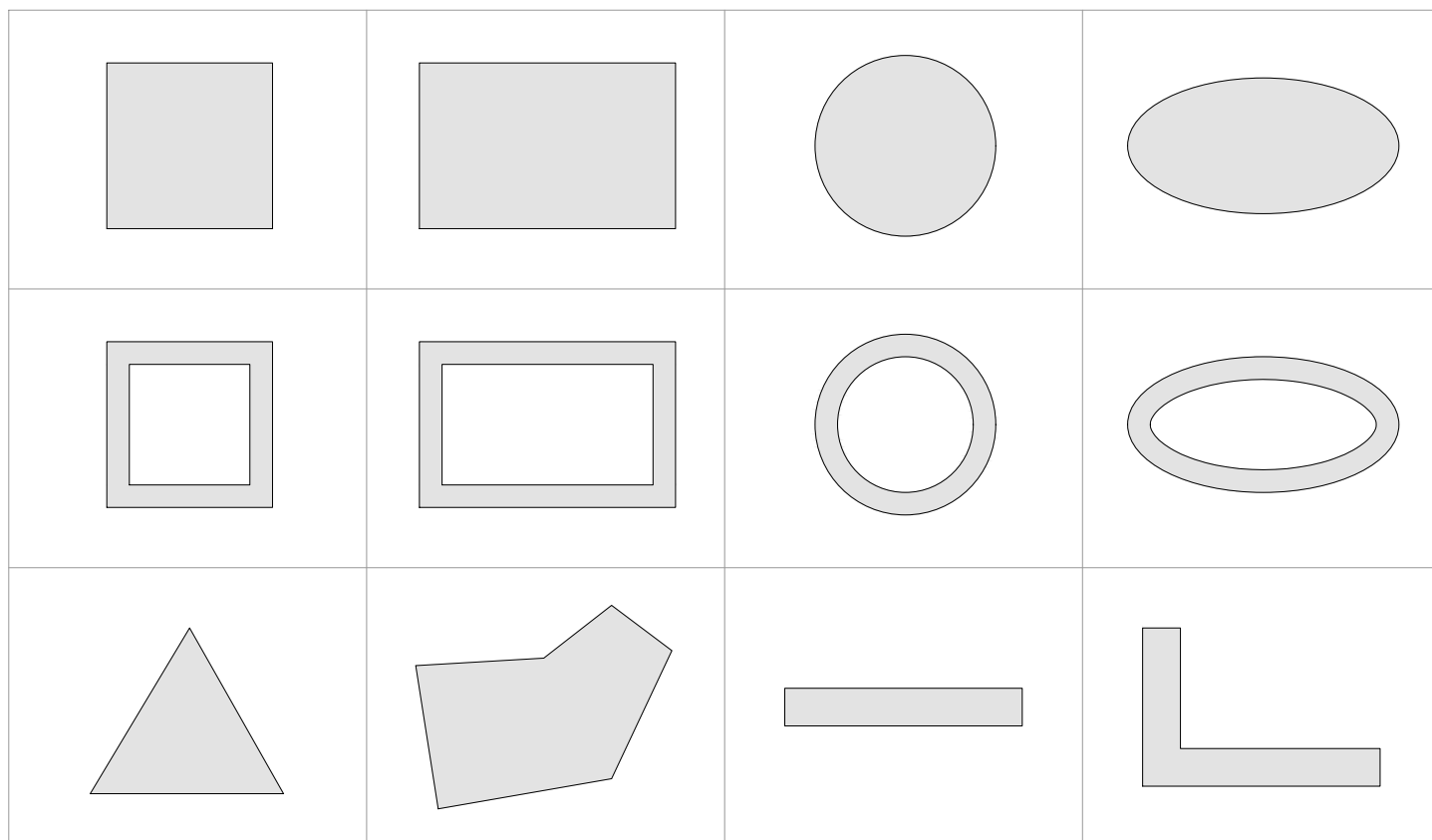

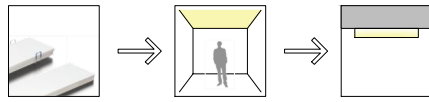

PRO magnets

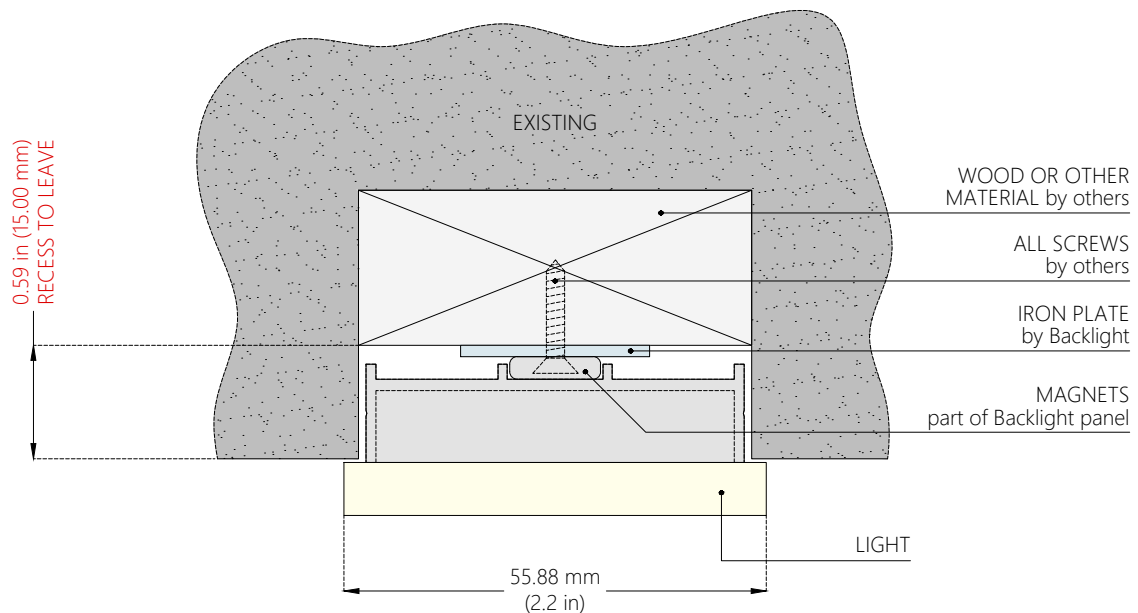

| | | |
|------------------|--|---|
| TYPE OF MOUNTING | RECESSED TRIM | |
| BACKLIGHT MODEL | PRO  | |
| MOUNTING SYSTEM | magnets and iron plate | |
| DIMENSION | MM width 19 - 29 - 34 - 39 - 44 - 54 - 59 - 80 - 104 - 204 mm INCHES width 0.8 - 1.2 - 1.4 - 1.6 - 1.8 - 2.2 - 2.4 - 3.2 - 4.2 - 8.2 in | MM length 101.6 to 3048.0 mm INCHES length 4.0 to 120.0 in |

EXAMPLE SECTION: 55.88 mm (2.2 in) WIDTH PRO

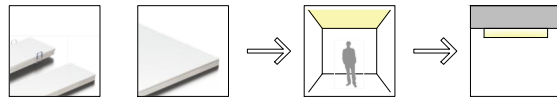



magnets and omega

| | | | |
|------------------|--|--|---|
| TYPE OF MOUNTING | RECESSED TRIM | | |
| BACKLIGHT MODEL | PRO  | MAGIC CLOUD  | |
| MOUNTING SYSTEM | magnets and omega channel | | |
| DIMENSION | Overall size: | MM width between 15.24 to 203.2 mm INCHES width between 0.6 to 8.0 in | MM length between 101.6 to 3048 mm INCHES length between 4.0 to 120.0 in |

SECTION: 3B

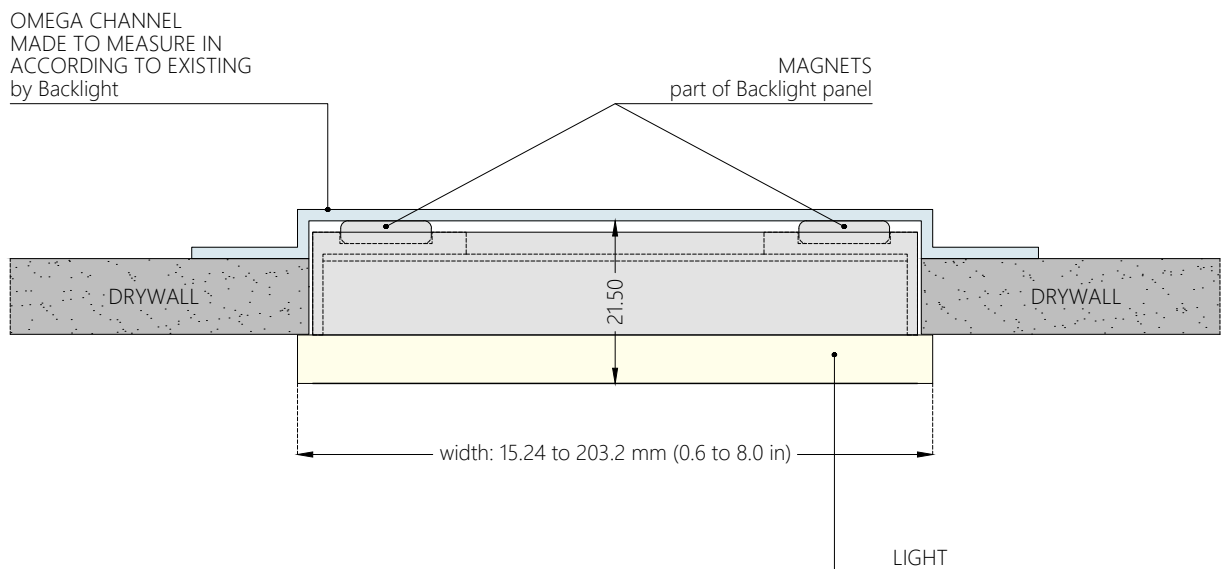

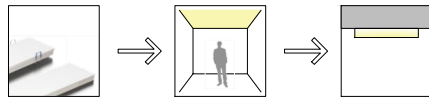

PRO springs

| | | |
|------------------|--|---|
| TYPE OF MOUNTING | RECESSED TRIM | |
| BACKLIGHT MODEL | PRO  | |
| MOUNTING SYSTEM | springs | |
| DIMENSION | MM width 19 - 29 - 34 - 39 - 44 - 54 - 59 - 80 - 104 - 204 mm INCHES width 0.8 - 1.2 - 1.4 - 1.6 - 1.8 - 2.2 - 2.4 - 3.2 - 4.2 - 8.2 in | MM length 101.6 to 3048.0 mm INCHES length 4.0 to 120.0 in |

EXAMPLE OF SECTION : 55.88 mm (2.2 in) WIDTH PRO

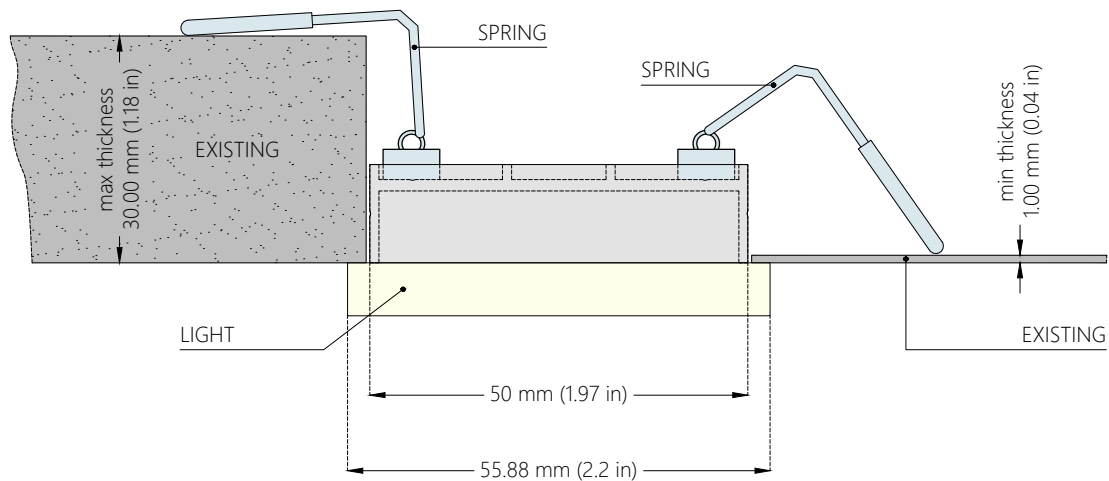

WALL

RECESSED TRIM

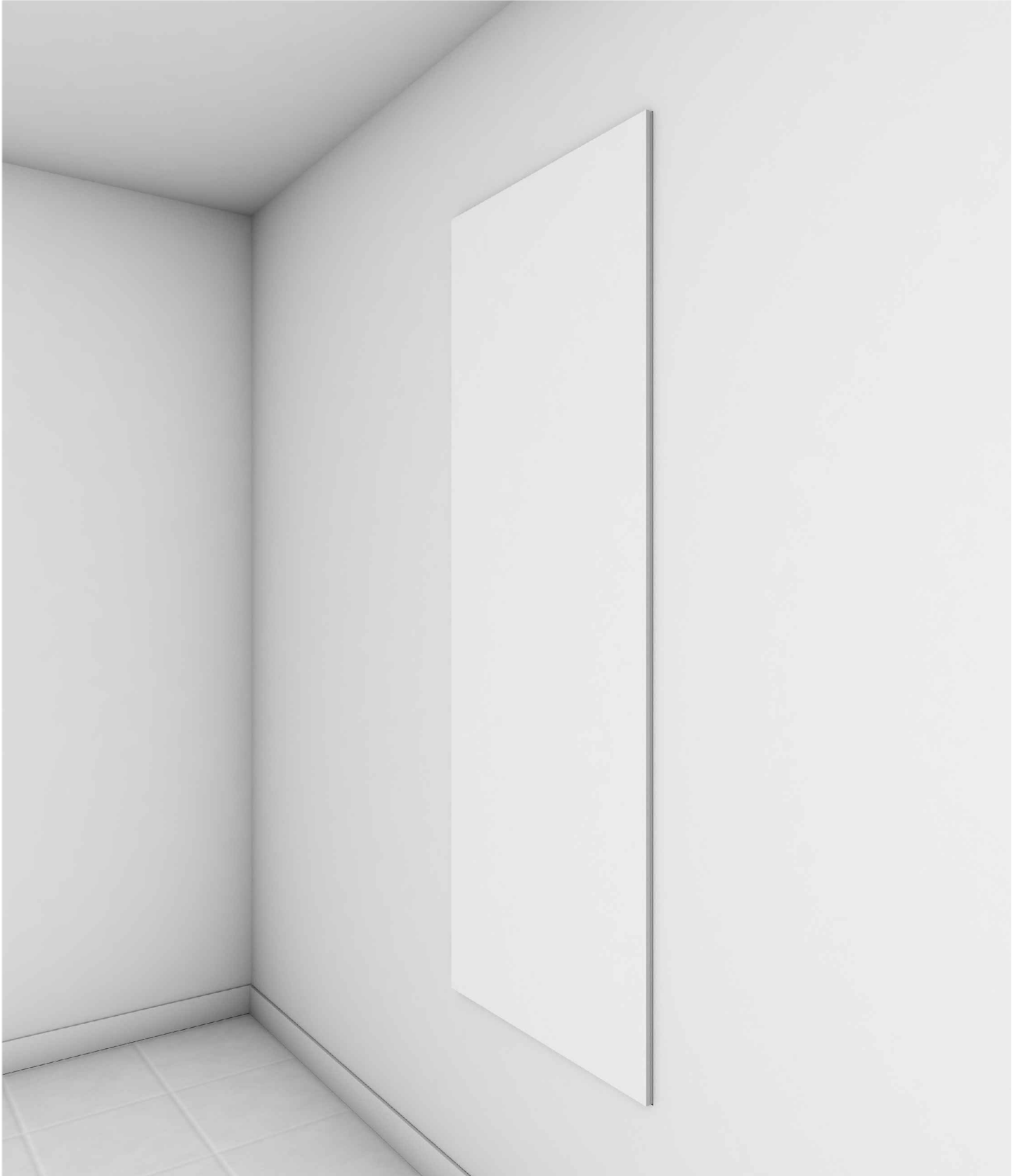

WALL RECESSED TRIM

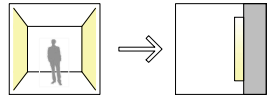

POSSIBLE CUSTOM SHAPES

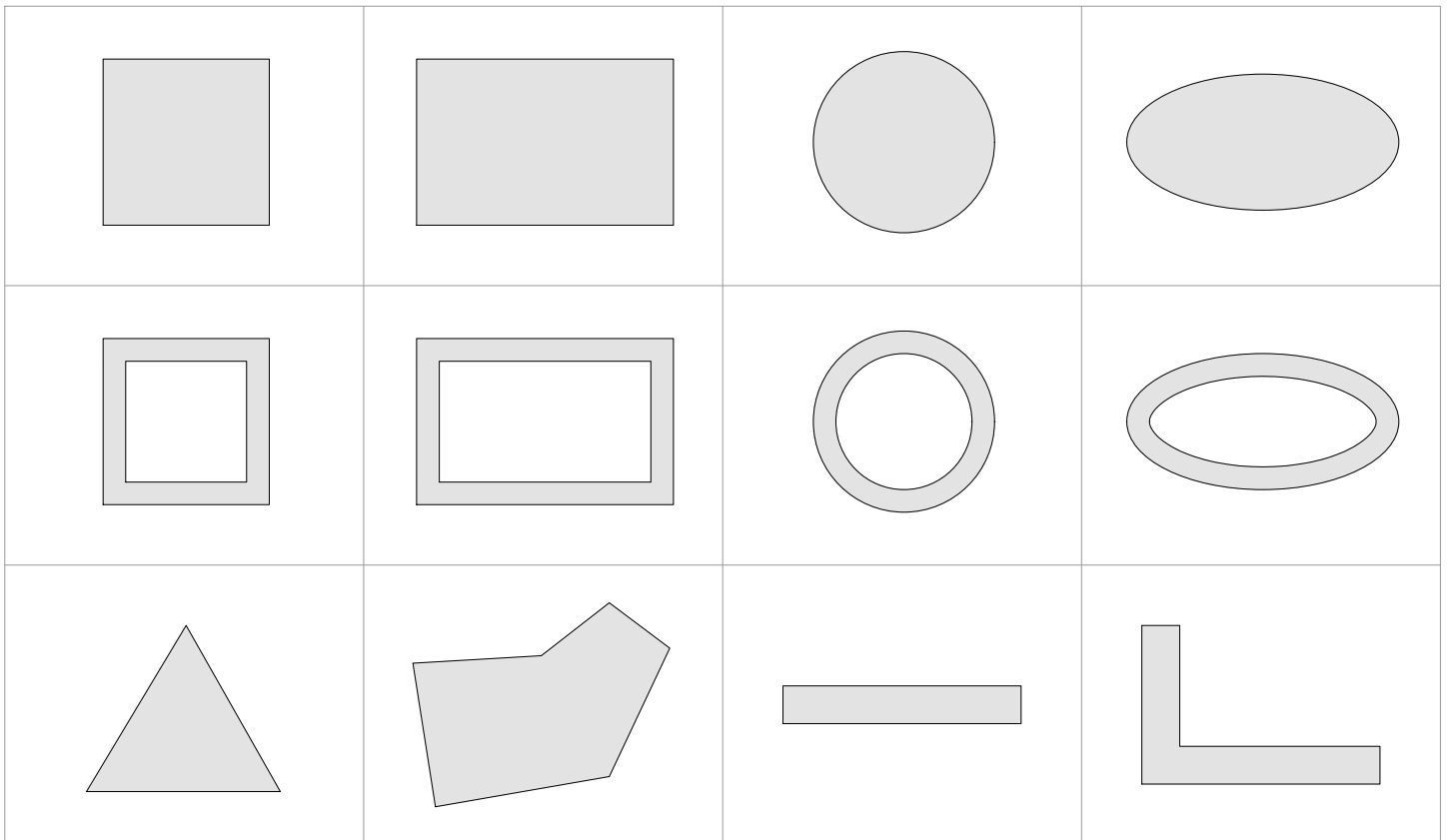
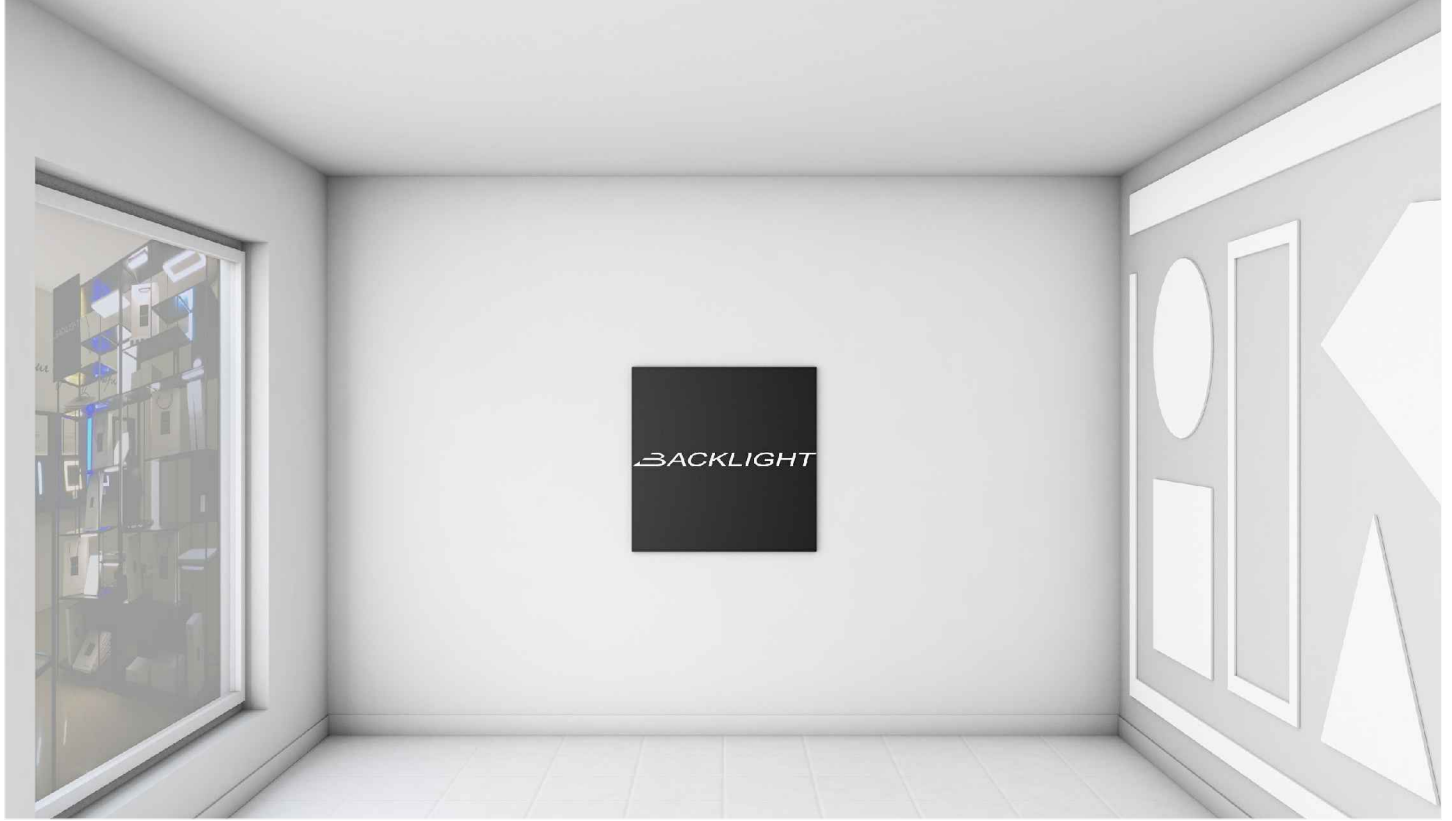

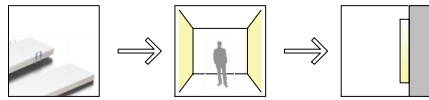

PRO magnets

| | | |
|------------------|--|---|
| TYPE OF MOUNTING | RECESSED TRIM | |
| BACKLIGHT MODEL | PRO  | |
| MOUNTING SYSTEM | magnets and iron plate | |
| DIMENSION | MM width 19 - 29 - 34 - 39 - 44 - 54 - 59 - 80 - 104 - 204 mm INCHES width 0.8 - 1.2 - 1.4 - 1.6 - 1.8 - 2.2 - 2.4 - 3.2 - 4.2 - 8.2 in | MM length 101.6 to 3048.0 mm INCHES length 4.0 to 120.0 in |

EXAMPLE SECTION: 2.2 in (55.88 mm) WIDTH PRO

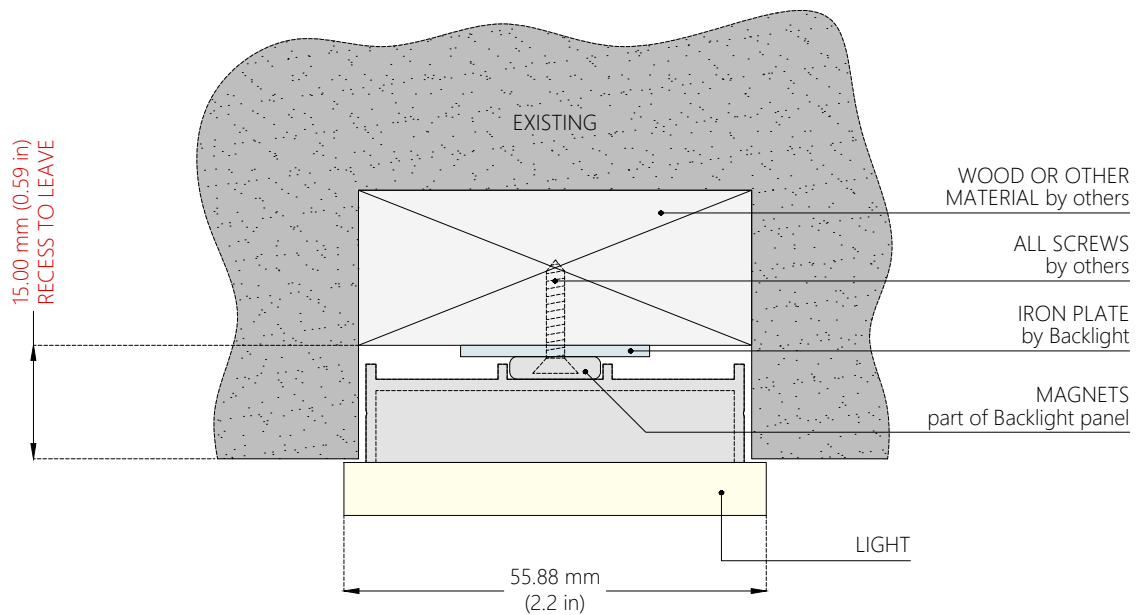

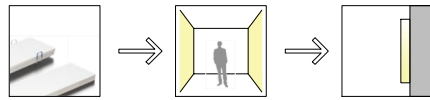

PRO springs

| | | |
|------------------|--|---|
| TYPE OF MOUNTING | RECESSED TRIM | |
| BACKLIGHT MODEL | PRO  | |
| MOUNTING SYSTEM | springs | |
| DIMENSION | MM width 19 - 29 - 34 - 39 - 44 - 54 - 59 - 80 - 104 - 204 mm INCHES width 0.8 - 1.2 - 1.4 - 1.6 - 1.8 - 2.2 - 2.4 - 3.2 - 4.2 - 8.2 in | MM length 101.6 to 3048.0 mm INCHES length 4.0 to 120.0 in |

EXAMPLE OF SECTION : 55.88 mm (2.2 in) WIDTH PRO

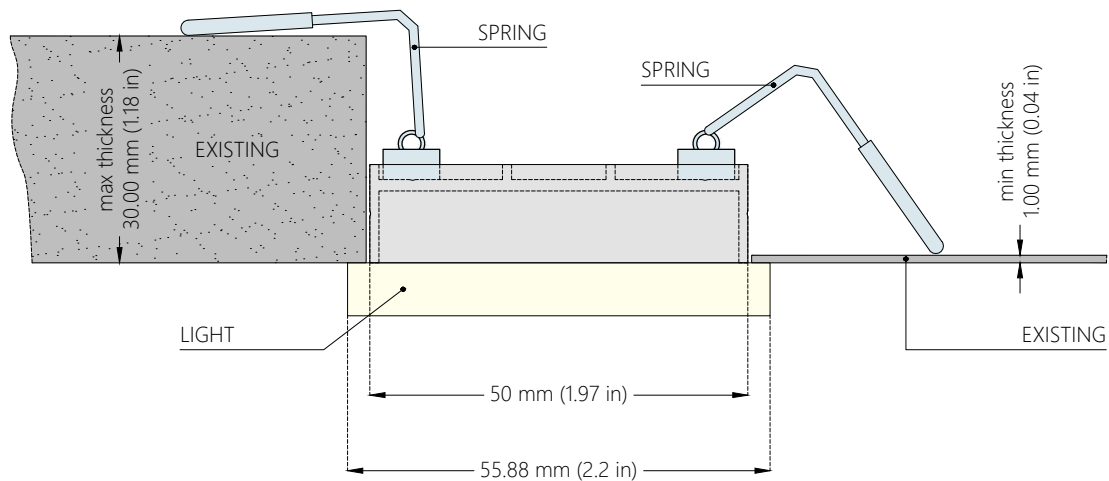

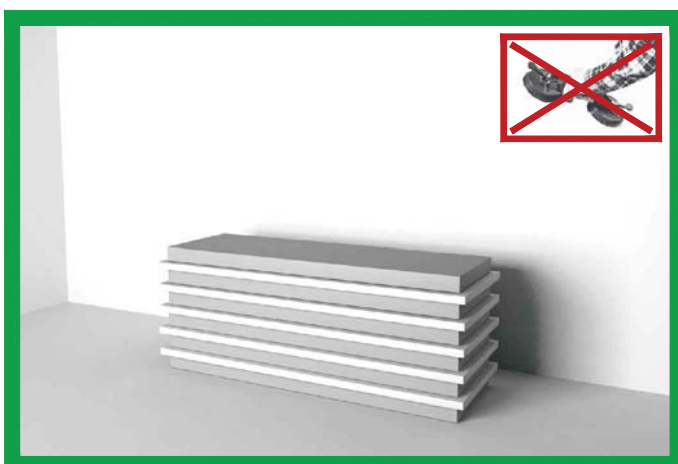
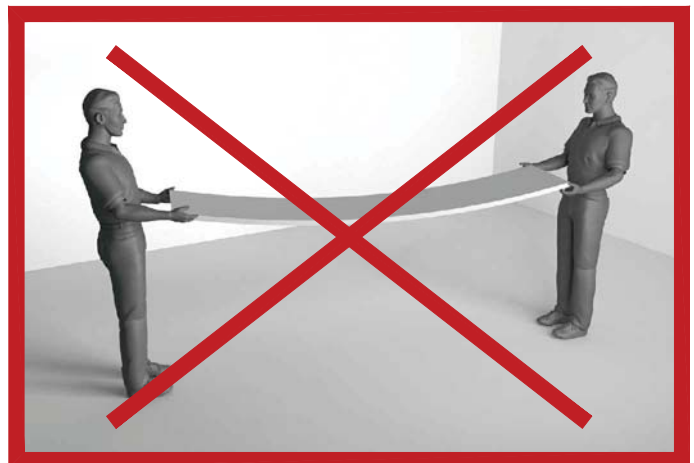
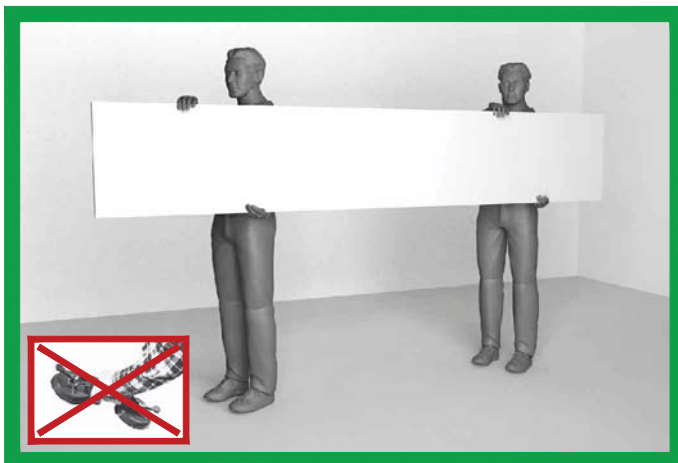
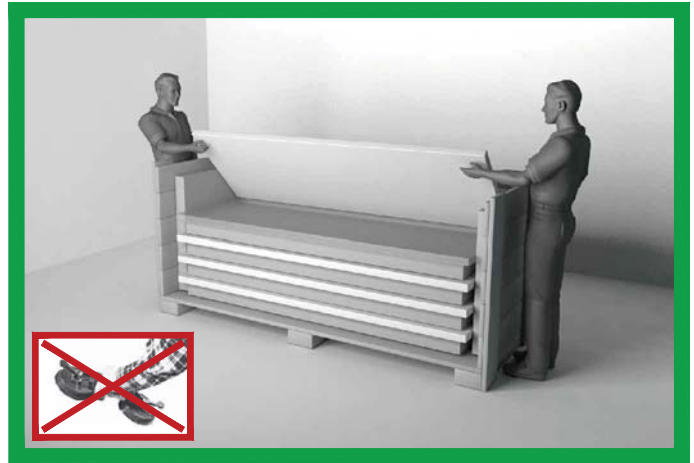

WARNINGS



DO NOT WET



DO NOT USE DETERGENTS



DO NOT USE HUMID FABRICS

BACKLIGHT srl

Via A. Volta, 5
20876 Ornago (MB)
Italy

+39 039 6010396
www.backlightsrl.com
info@backlightsrl.com